

REV. ZONE	REVISION DESCRIPTION	APPROVAL DATE

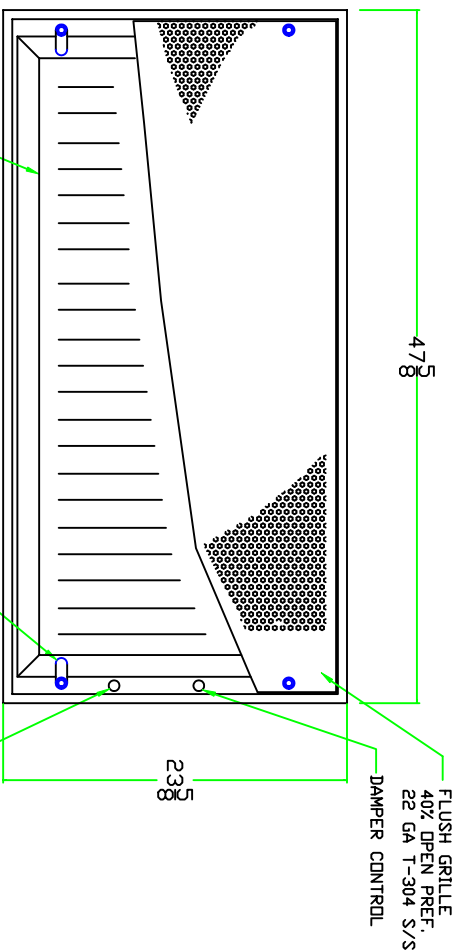

SPECIFICATIONS

1. CONSTRUCTION: THE HOOD SHALL BE CONSTRUCTED OF .063 ALUMINUM. ALL STRAIGHT SEAMS OF THE PLENUM SHALL BE CONTINUOUSLY WELDED. ALL OTHER JOINT SHALL BE INTERMITTENTLY WELDED AND SEALED WITH RTV SEALANT.

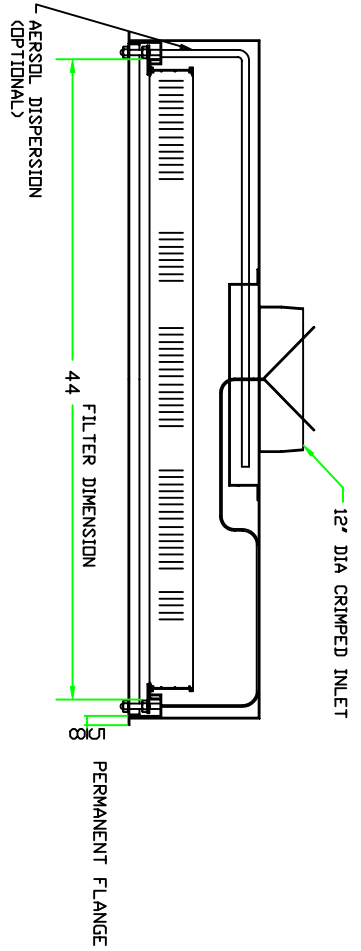
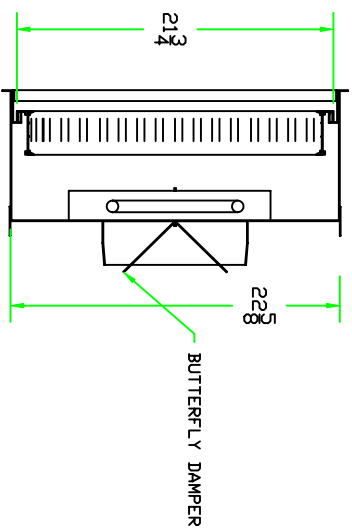
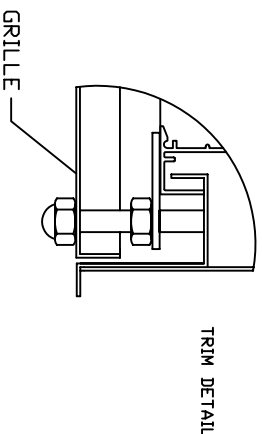

END VIEW

<p>© This document and the information contained herein is proprietary and may not be reproduced or used for any purpose without the expressed written permission of FILTRATION GROUP INC.</p>	
<p>APPROVALS</p> <p>DRAWN: A. ZELKO APPROVED: R. COTNER</p>	<p>DATE</p> <p>4-30-03 4-30-03</p>
<p>DESCRIPTION</p> <p>P-RTM 24X48 PERMANENT FLANGE</p>	<p>FILTRATION GROUP 9714 INDUSTRIAL DR. AURORA, IL 60506 630-264-2800</p>
<p>DWG NO: 41401 REV: 00 SHEET: 1 OF 2</p>	<p>TOLERANCES UNLESS OTHERWISE SPECIFIED: .XXX = ±.005 .XX = ±.03 ANGLES 1/16"</p>

REV. ZONE	REVISION DESCRIPTION	APPROVAL DATE

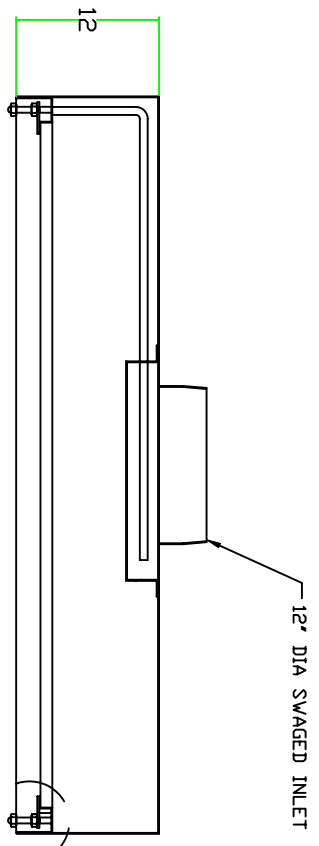

SIDE VIEW

DETAIL "A"

468

228

AEROSOL DISPERSION

BOTTOM VIEW

FILTER AND 1 1/4 S/S TRIM NOT SHOWN

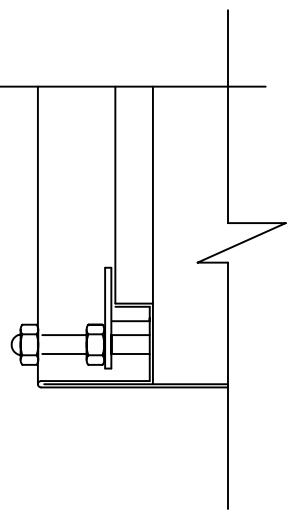

DETAIL "A"

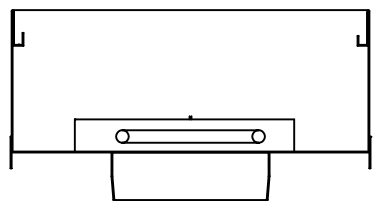

END VIEW

<p>© This document and the information contained herein is proprietary and may not be reproduced or used for any purpose without the expressed written permission of FILTRATION GROUP INC.</p>	
<p>APPROVALS</p> <p>DRAWN A. ZELKO 4-30-03</p> <p>APPROVED R. COTNER 4-30-03</p>	<p>DATE</p> <p>4-30-03</p>
<p>TO: ERANGES UNLESS OTHERWISE SPECIFIED</p> <p>.XXX = ±.005</p> <p>.XX = ±.03</p> <p>ANGLES 1/16"</p> <p>REMOVE ALL SHARP EDGES</p>	<p>DESCRIPTION</p> <p>THERMA HOOD</p> <p>24X48 - SS TRIM</p>
<p>REFERENCE</p>	<p>FILTRATION GROUP</p> <p>977A INDUSTRIAL DRIVE</p> <p>ARROW, IL 60506</p> <p>630-264-2800</p>
<p>REV 00</p>	<p>DWG NO 41401</p>
<p>SHEET 2</p>	<p>OF 2</p>