



FILTRATION GROUP

HEPA Seal Bag-In/Bag-Out



Operation and



Maintenance Manual



Table of Contents

SECTION	PAGE
Manufacture's Message	3
Introduction	4
Handling and Storage of Filter Elements	9
Installation of New Housings	9
Start up Procedures	10
Appendix A	19
Appendix B	20

MANUFACTURE'S MESSAGE

The HEPA Seal Bag In/Bag Out housings are designed to protect facility personnel and the general public from dangerous materials by filtering those materials. The filters that you are to change contain the filtered material. In order for you to be protected as fully as possible, you must follow these instructions as amended by your chief safety officer. The bagging method of changing a filter is not foolproof, but it is the safest practical method available for changing contaminated filter.

We realize that a single manual cannot address all types of housing designs and configurations, so we are offering the concepts of installing a new filter(s) into a new system and replacing dirty filters in systems that are already in operation. Once the concept is understood, both maintenance personnel and safety personnel can adapt the most suitable method to use considering the housing, location, type of filter, and any other items that can affect safety.

Carefully study this manual and the safety officer's amendments so that you have the entire procedure in mind before attempting filter change out. Be sure to have all tools and equipment on hand prior to actually beginning work. In this manual, we describe the Filtration Group banding method of sealing the bag.

The important thing to remember is to use this manual, your safety officer's instructions, and your own reasoning ability to prevent yourself and the immediate environment from being contaminated with the material that is captured on the dirty filter.

INTRODUCTION

Filtration Group's line of Bag-In/Bag-Out filter housings for fluid or gasket seal primary filters are side loading filter housings which have been designed to meet the air filtration needs of industries and research facilities that handle dangerous, toxic, biological or carcinogenic material. To minimize exposure to this harmful contamination while replacing and handling dirty filters, the housing incorporates a ribbed Bag-In/Bag-Out ring over which a heavy-duty plastic bag is attached (see picture below)



Empty housing depicting bag ring and filter retrieval rod
Figure 1-1

Once the initial filters are installed and the first bag attached, all filters- both dirty and new, are handled through the bag using the procedures described in detail throughout this manual. Depending upon the user's requirements, the housing may have an assortment of filter arrangements, including prefilters, HEPA filters and other type filter media. No matter what types of filters are contained within the housing, the filter change-out procedure is the same.

- Note- Filter change out is incomplete unless the new filters have been sealed to the housing frame and an in place leak test has been performed.

FLUID SEAL DESIGN CONCEPT

The filter to housing gel seal is effected by means of a continuous knife-edge on the interior of the housing, which mates into the gel filled perimeter channel on the face of the filter. To effect the seal, the locking mechanism forces the filter against the knife-edge. The knife-edge penetrates the gel and a uniform seal is produced on the filter face.



Locking arm of gel seal housing
Figure 1-2

DESCRIPTION OF FLUID SEAL FILTER LOCKING SYSTEM

The fluid seal Bag In/Bag Out housing has a filter-locking arm in each tier to operate the replaceable filter locking mechanism. By operating the internal filter-locking arm inside the PVC bag and access door, the filter is engaged on, or disengaged from, the housing knife-edge (internal sealing frame). The filter-locking arm and the access door interface in such a manner that minimizes the possibility of the door being closed until the filters are correctly sealed in the housing and sealed to the mounting frame.

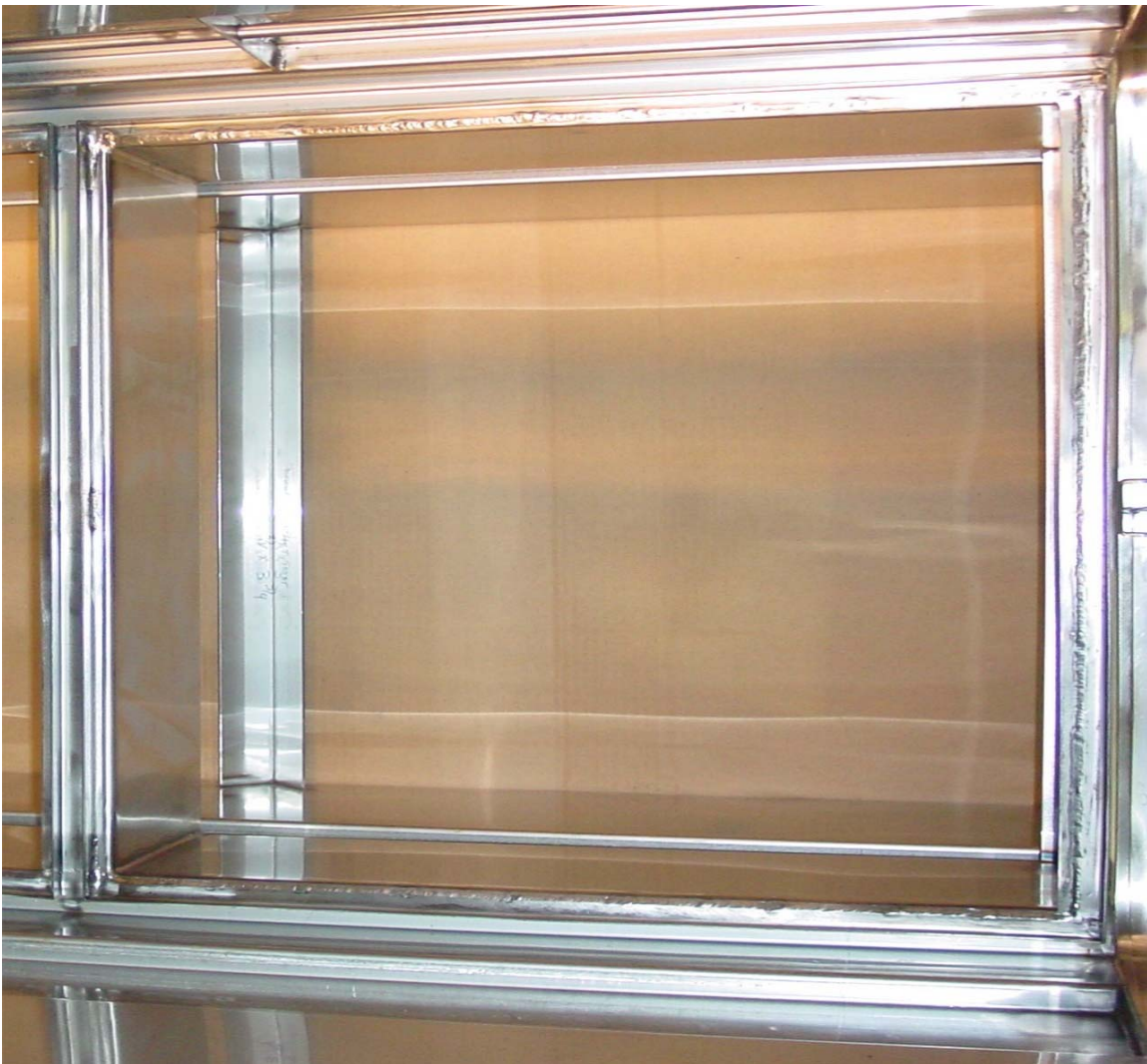

Interior knife-edge, locking arm and tray fully open
Figure 1-3

GASKET SEAL DESIGN CONCEPT

The filter to housing gasket seal is effected by means of a continuous flat mounting surface on the interior of the housing, which mates to a perimeter gasket on the filter. To affect the seal, the locking mechanism forces the filter against the mounting surface.



1H X 1W HEPA section- flat mounting surface
Figure 1-4

OPENING AND CLOSING GASKET SEAL LOCKING MECHANISM

By turning the drive bolt(s) clockwise located at the front exterior of the housing, independent pressure bars with preloaded springs, located in the filter locking mechanism, force the filter against the interior-mounting frame (there are two drive bolts per filter). Preloaded springs on each pressure bar, for each filter element, apply consistent pressure to maintain filter seal. The applied force has a minimum-clamping load of 1,400 pounds per perimeter of the filter. This force should be applied as an even, uniform load along the top and bottom of each filter frame. The gasket shall be compressed to and not exceed 1/8." ***Caution-** over compression of the gasket can lead to leaks. The standard locking mechanism hardware is 18-8 stainless steel with a 360-brass nut.

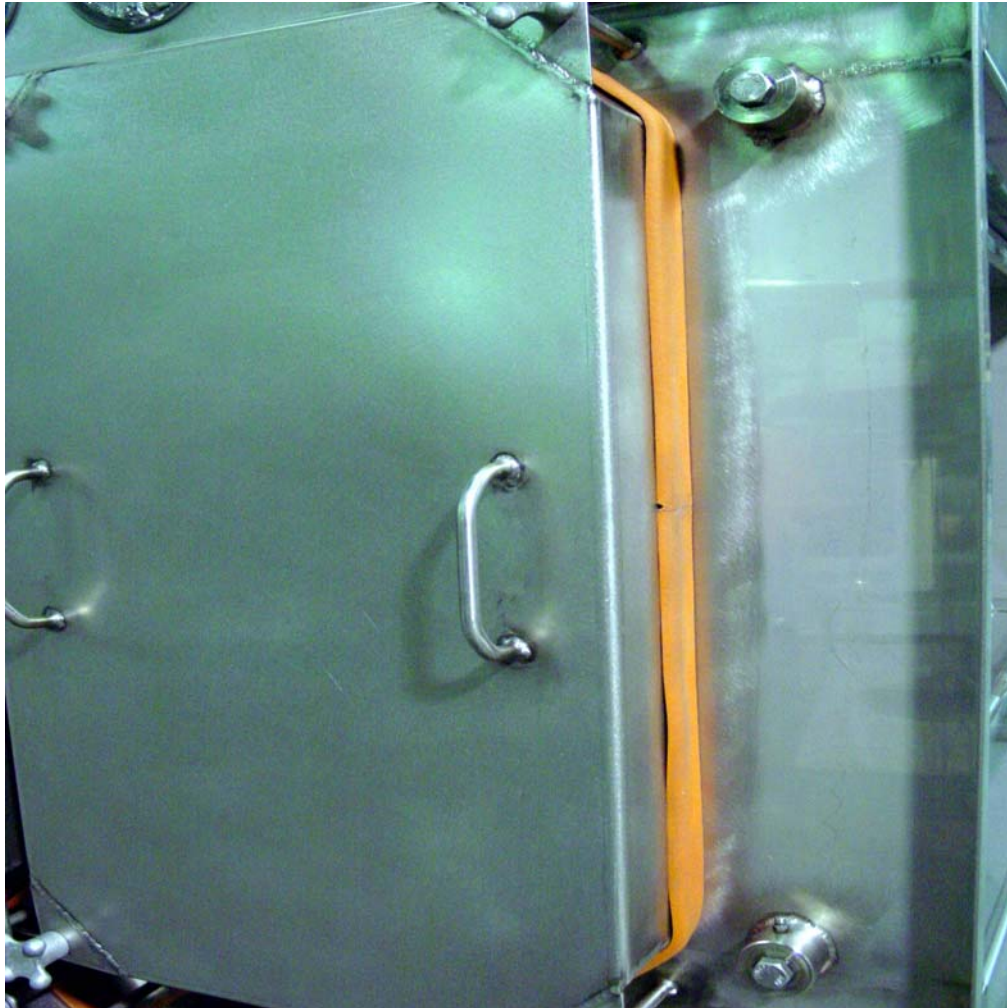

Top and bottom drive bolts located on right side of unit
Figure 1-5

HANDLING AND STORAGE OF FILTER ELEMENTS

Particulate filters include a wide range of filter types, sizes and performance capabilities. These filters are designed to remove airborne particulates from an air stream. Filters can consist of 30% efficient by ASHRAE prefilters and up to 99.97% efficient HEPA (high efficiency particulate air) filters. In general, all particulate air filters are fragile and should be handled with care. The following precautions should be observed upon storing filters:

- Keep in a clean low humidity air controlled environment.
- Filter should remain in its original shipping container with correct orientation until put in use.
- Temperature in storage area shall not be less than 0° Fahrenheit or more than 100° Fahrenheit.
- Stacking of filters is prohibited.
- Moving of filters should be restricted- lest the media become damaged.
- Shelf life is no more than three years for both gasket and gel seal filters (see manufacturer's instructions)
- All filter manufacturer's instructions and warnings shall be followed as well.

INSTALLATION OF NEW HOUSINGS

1. Position the housing adjacent to the ductwork. Housing should be welded, bolted or gasketed permanently to the ductwork.
2. Housing should be securely mounted to either a base or other permanent edifice.
3. Unit should be orientated as so the access door(s) can be easily removed and replaced.
4. Following installation, ductwork and housing should be cleaned to eliminate any and all contaminants as well as any other items, which may have been stored in the unit during shipping.
5. Install filter(s).

6. Perform designated leak test/DOP test (designated by either the chief safety officer or engineer) to insure that the unit is working properly and is not leaking.

START UP PROCEDURES

- System must be shutdown prior to any filter installation or removal. Airflow should be stopped or a bypass of the air system must be made. Any leakage through either the dampers or other airflow device will cause bag to suck tight against filter(s) and possibly cause damage to the bag.
 - Consult with safety officer and perform both a job safety analysis prior to installing or removing any filter(s) and make sure all personnel are wearing the required personal protective equipment (PPE).
1. Clean outside door, work area and all stainless steel surfaces.

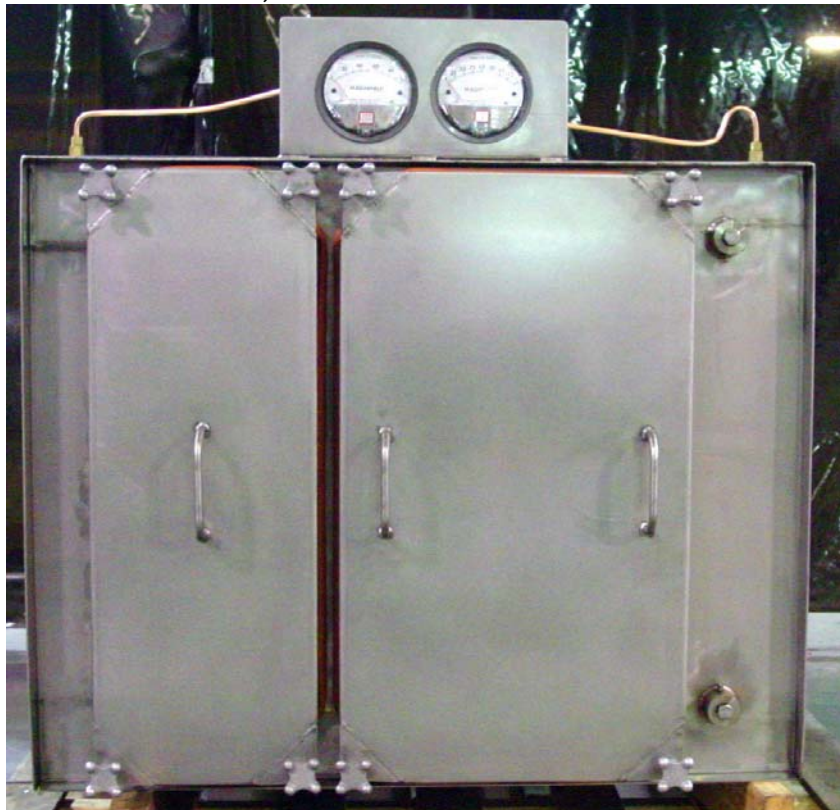

1H X 1W unit with pre-filter section
Figure 1-6

2. Provide Filter: Provide a new HEPA filter(s) and or prefilter for each tier.



Filter insertion
Figure 1-7



Worker with PPE
Figure 1-8

3. Provide Filter Support Shelf: A factory supplied support shelf should be located immediately outside of and a few inches below the door of the tier to rest the HEPA filter.

4. Provide Bag: Provide one new factory specified PVC bag for each filter tier. Always inspect bag for rips and tears before using.



Note elastic bag strap is placed inside second rib
Figure 1-9

5. Provide Sealer: A factory supplied banding kit should be used to tie off the PVC bag. Further, the safety strap should be cinched as so it lies flat against the sealing lip between the two humps.



Safety strap location between the two ribs
Figure 1-10

6. Remove Door: Loosen all doorknobs on the section that the filter(s) are to be removed. Place door(s) in a safe location.

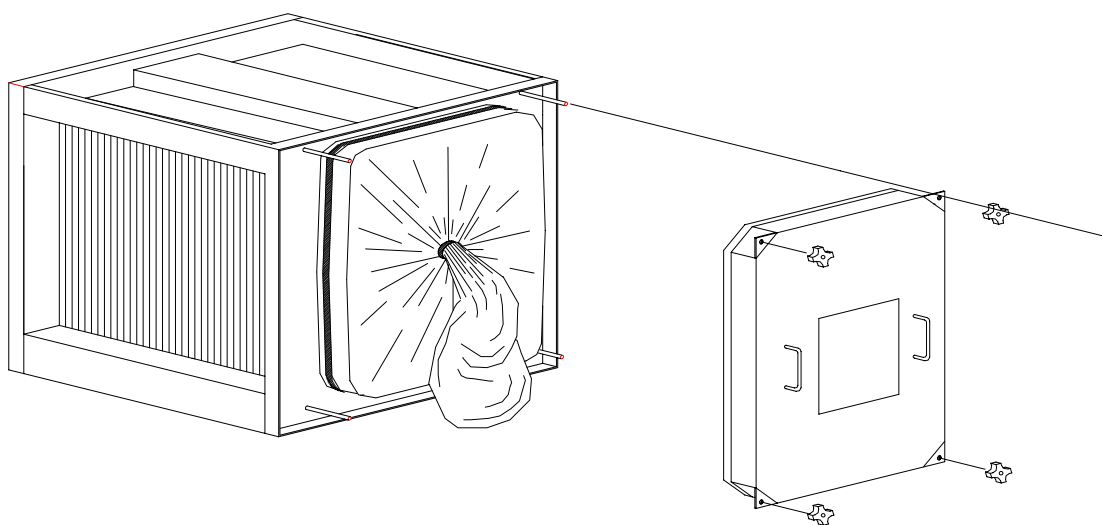

Note bag safety strap and cinch strap
Figure 1-11

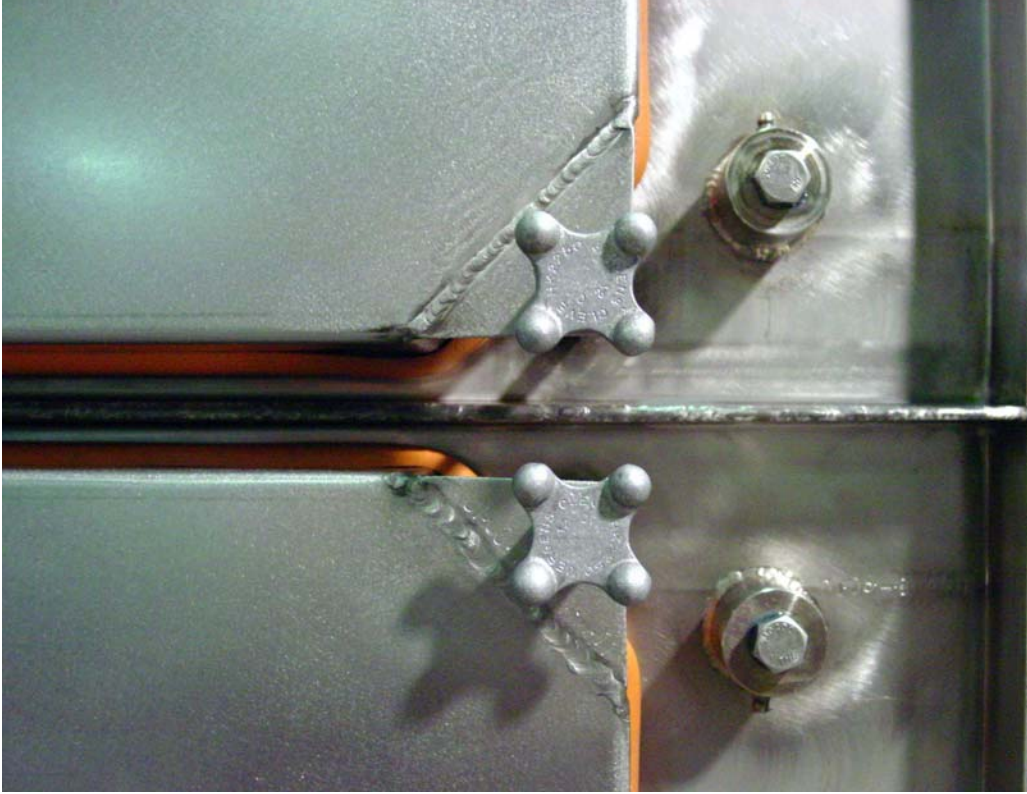

There are at least four doorknobs per door-2H unit shown
Figure 1-12

7. Remove Cinching Strap and Open up Bag: (make sure that the safety strap remains on the bag out port)

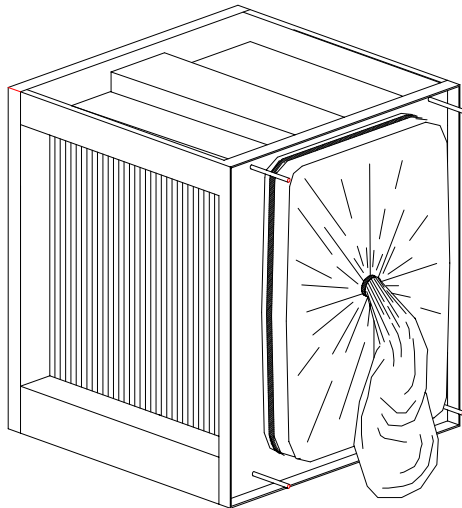

Cinch strap in center
Figure 1-13

8. Unseal The Filter: Using the mittens, which are incorporated into the bag, release the filter-locking latch. For a fluid seal housing, press the arm firmly inward toward the filter at a point near the latch to relieve the tension and the latch will automatically spring to one side releasing the arm. Next pull the arm all the way outward to the open position. This allows the filter to release from the knife-edge.



Figure 1-14-note bag is resting on a parallel flat surface and not the floor

For a gasket seal housing, unlock filter by turning both bolt locking mechanisms counterclockwise with a ratchet. This will release the filter from the flat edge.



Bag not shown for visualization effect
Figure 1-15

9. Use filter retrieval rod to latch onto and pull filter into the PVC bag. One can also reach into unit and pull filter out on a one wide unit. Slide the filter as far into the bag as possible. A residual bag stub from previous filter changes may exist. This should be removed along with the filter.

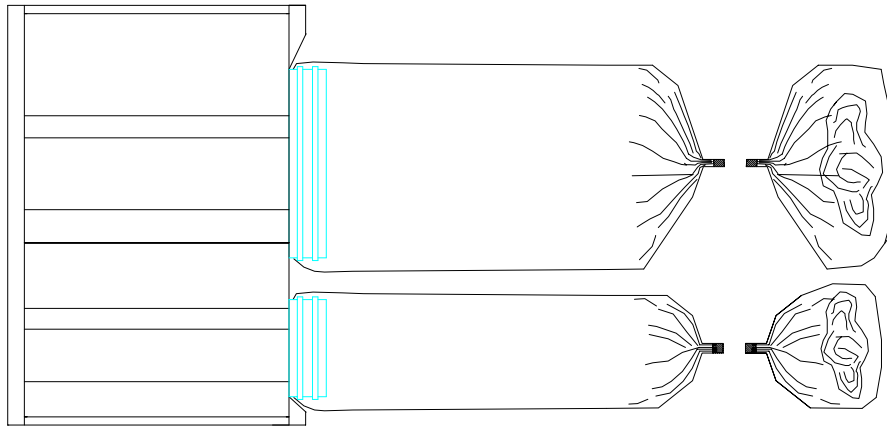

Residual filter bag stubs shown of both pre-filter and HEPA filter
Figure 1-16



Hand within mittens shown
Figure 1-17

10. Seal the bag – cinch the bag twice with metal bands between the removed filter and the housing. Cinch(es) is provided in the

banding kit. If factory approved tape is used, then twist the bag and tightly tape a six-inch section.

11. Cut the bag between the two cinches. (Approximately $\frac{1}{4}$ " to $\frac{1}{2}$ " apart) One cinch will remain with the removed filter and the other will be sealing off the housing. If tape is used, cut in the middle of the taped off section and immediately retape the exposed stubs.

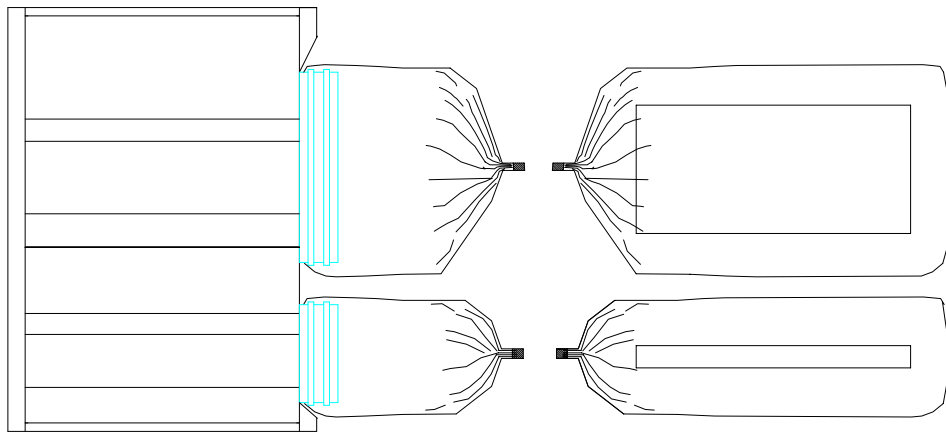

Top view of both a pre-filter and HEPA filter change out-sealing lip in blue
Figure 1-18

- * **If there are multiple filters per tier steps 9-11 should be repeated until all filters are removed.**

12. Remove bag(s) with dirty filter(s) and dispose of in accordance with all applicable state and federal laws.
13. Remove safety strap from the sealing lip and slide the shock cord of the bag from the inside rib to the center of the bag-bagging ring between the two ribs.

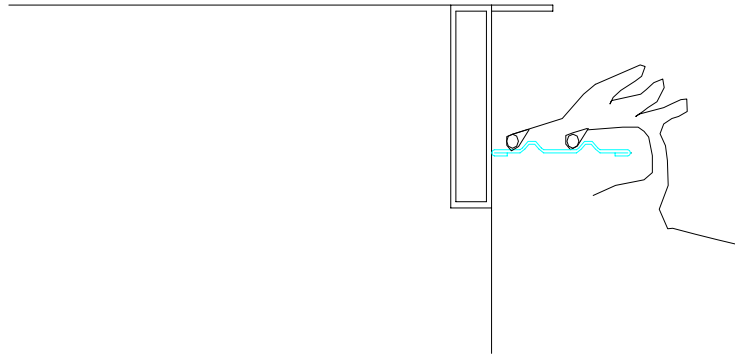

Bag cords on sealing lip-profile, sealing lip in blue
Figure 1-19

14. Place new filter in a new PVC bag. **Note-** only the frame of the filter should be touched. Locate the new bag's shock cord around the bag out port on the inside rib (where the previous bag was located). Make sure the stub from the previous bag is within the new bag.
15. Tighten safety strap on the new bag until it is immobilized and cannot move. (See Figure 1-10)
16. Pull old bag and stub into the new PVC bag and away from the new filter.
17. Slide Filter(s) into housing and engage locking mechanism to seal off filter(s) on knife edge(s).
18. Close swing bar and latch for a gel seal filter or screw down drive bolts clockwise on a gasket seal filter.
19. Cinch bag as so it is taught across the surface of the sealing lip. Caution: do not cinch bag so tight as to cause the shock cord to slip off of the sealing lip (See Figure 1-13).
20. Roll bag up-Replace the Door and tighten all Door Latches.



Figure 1-20

APPENDIX A

It is recommended that the buyer supply complete information about the operating conditions of the ventilation system prior to installation of any Bag In/Bag Out contamination system. Location specific conditions may prevent the system from operating satisfactorily for certain applications. Any non-factory alterations to the product may result in a compromised installation. Please contact manufacturer for any questions not addressed in this manual.

Filtration Group Inc
912 E. Washington Street
Joliet, IL 60433
Phone 1-800-739-4600
Fax 1-800-518-1162
<http://www.filtrationgroup.com>

APPENDIX B

LOCKING TRAY CHANGE OUT

It is advised that any locking tray mechanism replacement or change out be done in a decontaminated environment. Due to sharp edges, placing a metal locking tray in a PVC bag is not recommended. However, one of the advantages of the HEPA Seal Bag In/Bag Out contamination housing is the ability to change out locking trays in the field.

Change out is a simple task. The same concept applies to locking mechanisms as that to filters (refer back to start up procedures).

First, remove all filters from the contamination unit following the **Start Up Procedures** aforementioned. Insert a new bag with a standard ratchet with a 1/2" socket in the bag. For Gel seal units a 3/8" socket will be needed as well. Position the new PVC bag's shock cord the same way you would for a PVC bag with a new filter in it. Remove the old bag stub in the new bag.

FLUID SEAL METHOD

1. Using the ratchet with the 1/2" socket remove the two hex nuts and washers for both the top and bottom locking trays.
2. Then switch to the 3/8" socket and remove the hex nut and washers from the linkage to the door swing arm.
3. Remove both the top and bottom parts to each pair of locking trays and pull into the PVC bag.
4. Treat the locking mechanism as a dirty filter and continue the appropriate steps.
 - **Warning-** ratchet and socket must remain in the bag. Do not remove.

GASKET SEAL METHOD

1. Using the ratchet with the ½” socket remove the two hex nuts and washers for both the top and bottom locking trays.



Downstream view of locking tray mechanism
Figure 1-21

2. Lift the top half of each locking tray off of the studs and into the bag.
3. Remove the pipe bearings from the locking mechanism and back off the drive bolts to release the bottom locking trays.
4. Remove the bottom-locking tray and pull into the PVC bag.
5. Treat the locking mechanism as a dirty filter and continue the appropriate steps.
 - **Warning-** ratchet and socket must remain in the bag.
Do not remove.